

SWEEPER-HGW

SPEED GATES

Sweeper-HGW is the ideal solution when you require a speed gate with both tall glass panels and an extra-wide passage. This model offers a passage width range of 550 to 1200mm, catering to diverse accessibility needs. The overall height of the speed gate is 1500mm, with the possibility of extension up to 1800mm.

The Sweeper-HGW is specifically designed to address projects where standard DDA speed gates with a 900mm width fall short.



PERFECT SOLUTION WITH HIGHER DEGREE OF SECURITY



Key features:

- BMDrive® - a reliable mechanism with a powerful BLDC gear motor ensures long-term, maintenance-free operation.
- The speed gate is equipped with a smart self-diagnostic system.
- An innovative controller with an OLED display and buttons allows for easy setup and configuration without the need for special programmers.
- Digital control of force and leaf speed, combined with safety sensors, prevents accidents and ensures the safety of individuals, even in cases of unauthorized passage.
- The sensor system enables the detection of individuals with luggage or allows for a free exit without the need for identification.
- Elegant cabinets come equipped with integrated LED lighting that displays the access status and card reader area.
- The housing design and top lid can be customized to meet specific preferences.
- Can be seamlessly integrated with any type of access control system.
- A wired remote control panel is included as part of the standard kit.
- Low power consumption.
- In the event of a power failure, the leaves can be manually opened (fail-safe).

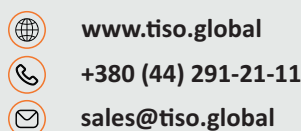

TECHNICAL SPECIFICATIONS/

Model	Sweeper-HGW 1200
Cabinet width, mm	192
Cabinet length, mm	1750
Cabinet height, mm	1010
Cabinet height, mm	1500/1800
Passage width, mm	1200
Opening/closing time, sec	1,8
Mechanism	BMDrive® servodrive (BLDC)
Blocking system	ToothLock®
Emergency mode (fire-alarm)	Free entry/exit (leaves are opened automatically)
Power fail	Fail safe (gates could be opened manually — standard)
MCBF, cycles	5 000 000
MTTR, min	< 25

Electrical Specifications:

Maximum power consumption, W	160
Voltage	From the AC (100-240)V, 50/60Hz; from a DC source 12 V
Indication	DotLights®, RFIDLights®, EdgeLights®

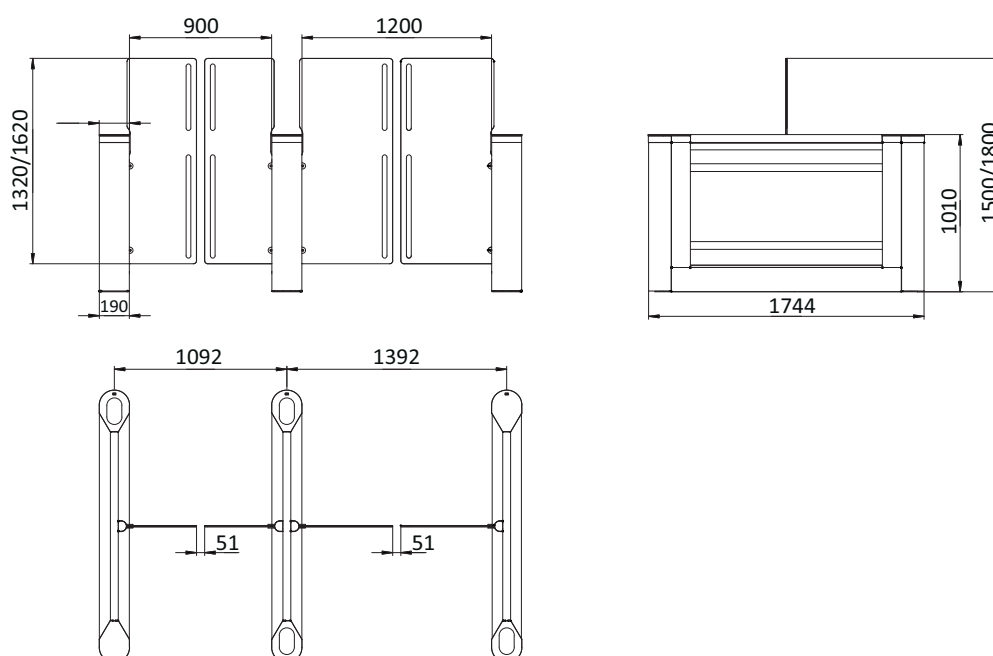

Finishing

Standard housing	Brushed SS AISI 304
Available housing	Brushed SS AISI 316; Polished SS AISI 304; Polished SS AISI 316; Powder coated RAL



Specifications are subject to change without prior notice.



 www.tiso.global
 +380 (44) 291-21-11
 sales@tiso.global



STANDARD FEATURES



LED INDICATIONS

Introducing our RFIDLight® and DotLight® features, designed to captivate attention and enhance user experience:

RFIDLight®: Illuminates card reader area.
DotLight®: Displays access status.



CONTROL PANEL

Included in the standard set, our wired control panel offers versatile functionality: Facilitates single passage and free passage modes. Enables access blocking and activation of the anti-panic function.



SAFETY SENSORS, ANTI-TAILGATING FUNCTION

Our high-precision sensors excel in identifying unauthorized passage, effectively preventing tailgating by detecting two or more individuals. Additionally, our safety sensors ensure secure passage for individuals with luggage or trolleys, ensuring gates remain open until the passage is completed.



UPS FUNCTION

Introducing our advanced UPS system, seamlessly integrated to automatically switch power to the backup battery during outages. This ensures uninterrupted functionality of our speed gate, empowering you to utilize all features even in the event of a power failure.



EDGELIGHTS®

Impressive illumination of the glass housing can be in three colors (standard), marking the status of passage: blue - standby mode; green - access authorized; red - access denied.



PLACE FOR RFID INSTALLATION

RFID installation space included in standard speedgate configuration.



www.tiso.global

+380 (44) 291-21-11

sales@tiso.global



ADDITIONAL OPTIONS /

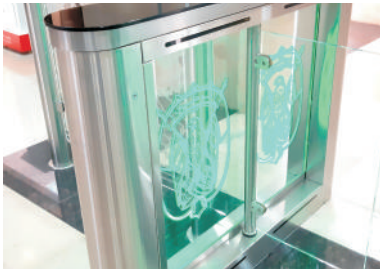

PATTERN APPLICATION

Customize your speed gates with unique signatures, patterns, logos, and more, seamlessly placed on the leaves, housing, or top lid for a distinctive touch.



MP3 AUDIO MODULE

Enjoy a comprehensive audio signaling system for various gate events: access / authorised access / closing / opening / alarm.

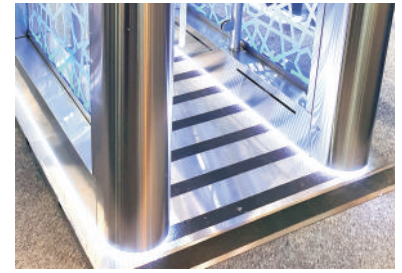

FOOTPRINT ILLUMINATION

Illuminate the footprint of the speed gate housing with LED lighting. Customize the color of the light to suit your preferences.



INTEGRATION OF CUSTOMISED ACS

Seamless integration of various access control systems upon request, including RFID devices, coin acceptor push buttons, fingerprint scanners, face recognition, barcode readers, and QR code readers.

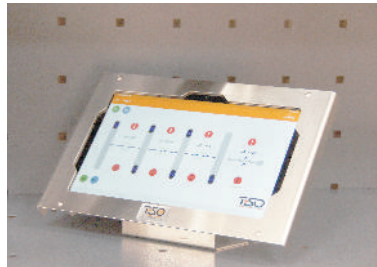

TWIC WIRELESS CONTROL PANEL

TiSO TWIC offers remote control for multiple lines of turnstiles. With its space-saving 10" touchscreen display, it can be conveniently placed at reception desks or within security control areas.



SUPER CAPASITOR

Ensure uninterrupted operation with our free power package, enabling emergency automatic one-time opening of the speed gate.



CARD COLLECTOR INTEGRATION

Integration of automatic card collector directly into the speed gate housing is possible.



PASS COUNTER

Automatically counts the number of passes for efficient tracking and management.



EXIT BUTTON

Introducing a convenient touch-free button option for organizing exits effortlessly.

ADDITIONAL OPTIONS

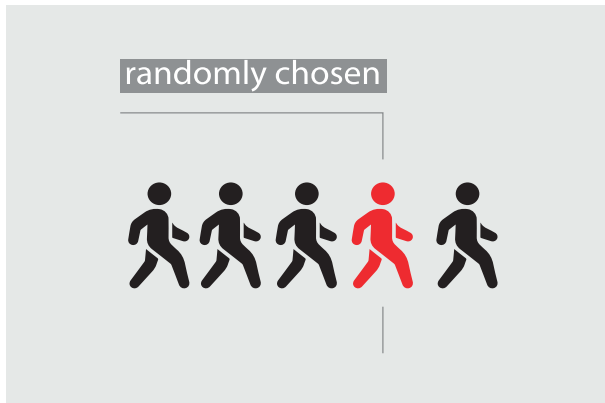

RANDOMISER

This mechanism autonomously selects individuals for verification without human intervention, ensuring impartiality.



RFID READERS T-PROX MINI

The reader is compatible with 125 kHz cards, Mifare, Mifare Plus, as well as mobile credentials U-Prox ID via NFC and 2.4 GHz radio.

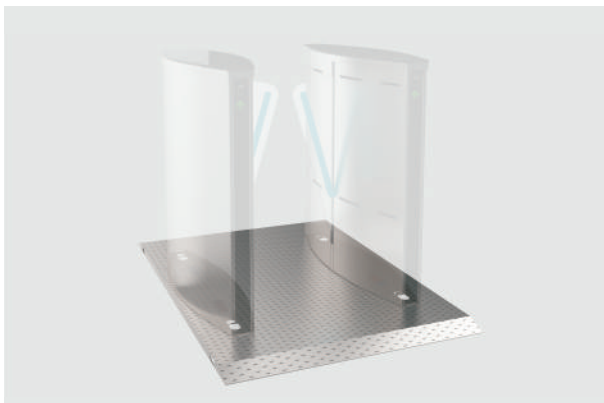

MOBILE PLATFORM

Enables rapid temporary installation of the speed gate, ideal for areas where floor drilling is not possible.



ALARM BUZZER

Audible alarm activated upon unauthorized access.